

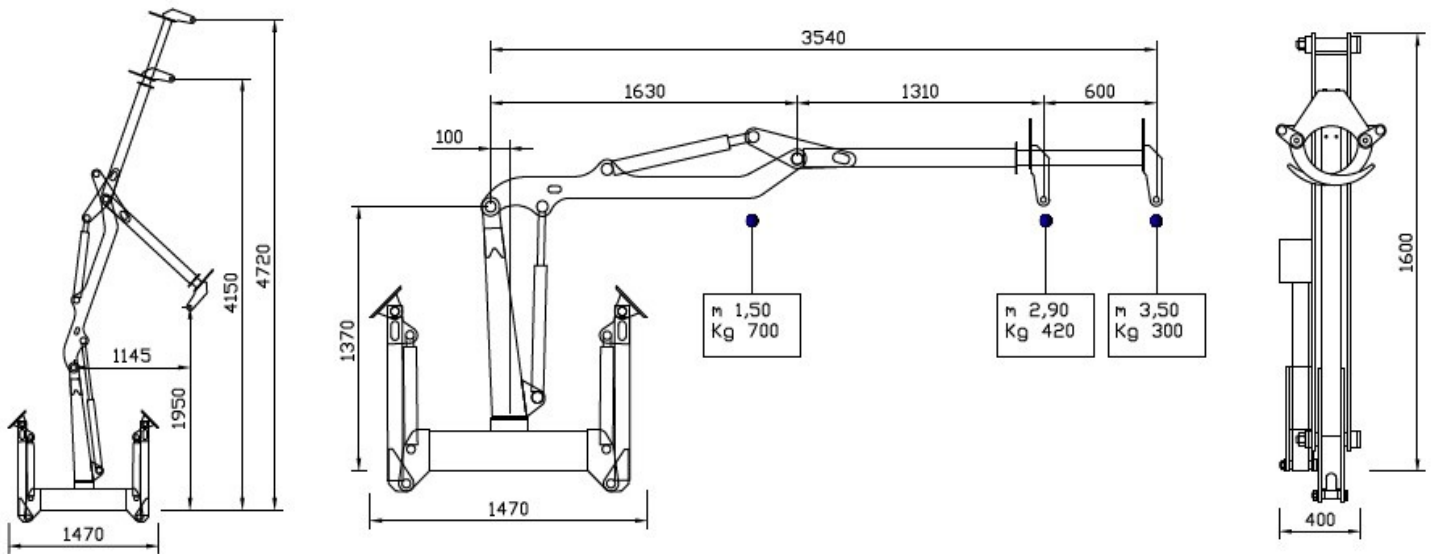





# XFORST XF 350 Z



							
3.50 mt	1	12 KNm	300 kg	20°	360°	20 lt/min	650 kg

## ACCESSORI DI SERIE:

- STABILIZZATORI IDRAULICI COMANDATI SINGOLARMENTE
- DISTRIBUTORE IDRAULICO A DUE CLOCHE E QUATTRO LEVE
- SISTEMA DI ATTACCO PER CARRO FORESTALE O AL SOLLEVATORE (SPECIFICARE NELL'ORDINE)
- BRACCIO TERMINALE TELESCOPICO, CHIUSURA DEL BRACCIO A "Z"
- **POSTO DI GUIDA** IN ALTO CON SEDILE O **COMANDI BASSI A TERRA** (SPECIFICARE NELL'ORDINE)
- SERBATOIO DELL'OLIO INCORPORATO NELLA BASE
- VALVOLA DI BLOCCO SUI CILINDRI DI SOLLEVAMENTO
- TUBI OLEODINAMICI RICOPERTI DA GUAINA ANTIUSURA.

